

version .0

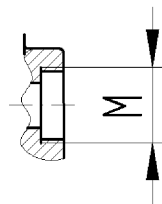
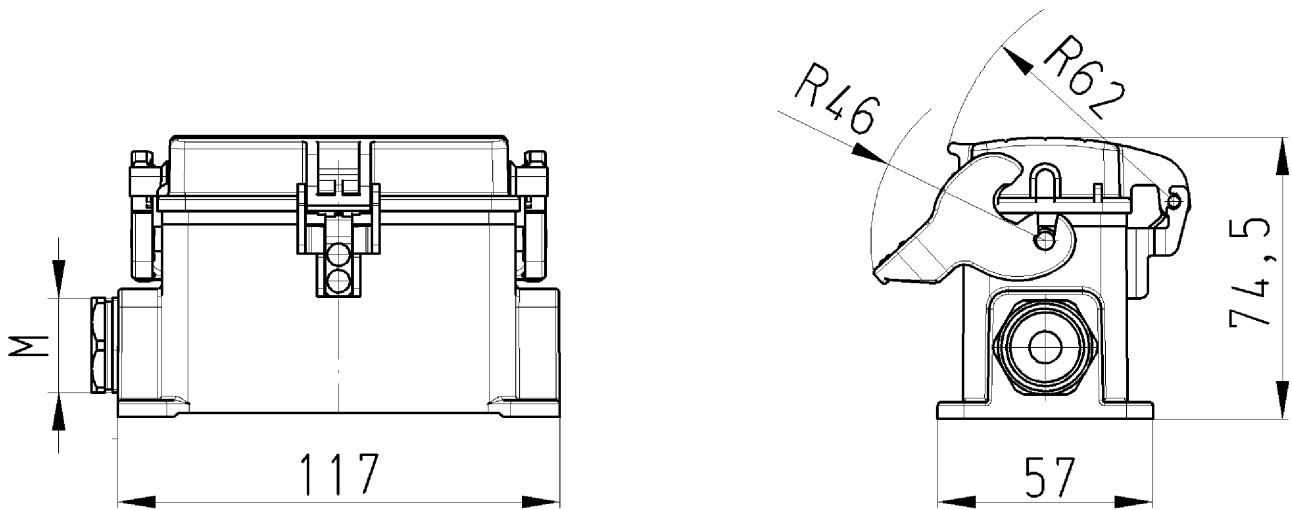

version .1

Gehäuseunterteil
71.342.1635.0

Zeichnungsnummer
71.342.1635.010W
Gehäuseunterteil

11.12.2007
Hoffmann Angelika
M 1:2